



XPPC Series

Ultimate Performance

PP-9745 15" / PP-9745W 15.6"



Aluminum Die-Casting
Stylish and Robust



Intel CORE
UNLOCKED
14TH GEN

High Performance
12th Gen Intel Core Processors
14th Gen Intel Core Processors (Optional)



Add-on Device Options
For A Variety of Usage



Flexible 2nd Display Options

LCM Customer Display / Smart-DP Monitor / XM-3015/W Arm Type Monitor



Smart-IO
Extended Availability

PUSB Hub Installed Underneath Stand / Xation



One Cable Solution
Video+Power+USB







Smart-DD Monitor XM-3010W / XM-3015 / XM-3015W





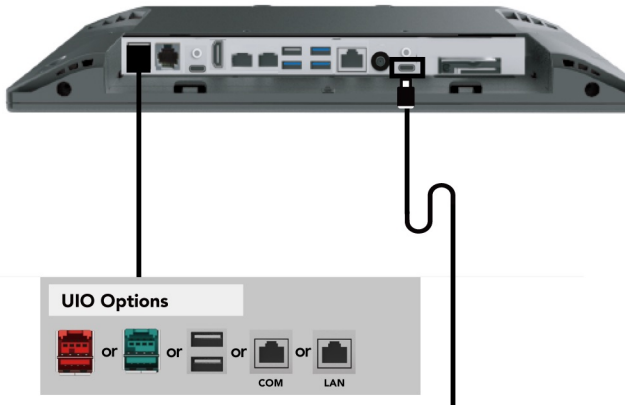

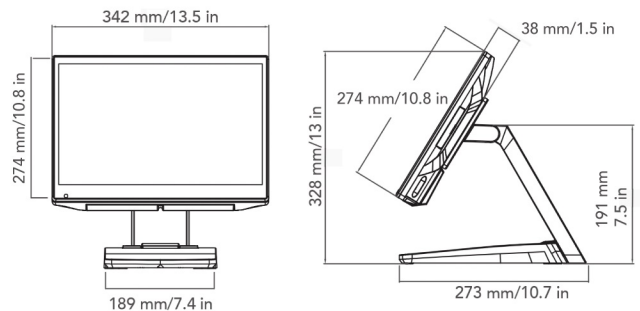

XPPC Series PP-9745 SPECIFICATIONS

XPPC Series
Panel PC

PP-9745

Model	PP-9745													
Processor	12th Gen Intel® Core™ i3-12100 / i3-12100TE / i5-12400 / i5-12500TE / i7-12700	14th Gen Intel® Core™ (Optional) i3-14100T / i5-14500T / i7-14700T												
Memory	4GB Standard, Max 32GB (1 x SO-DIMM DDR4)													
Storage	1 x M.2 M key PCIe GenIII NVMe													
Display	15" TFT, 1024 x 768 4:3													
Brightness	350 nits													
Touch	True-Flat PCAP (Default) / AG Coating (Optional); Conducted Susceptibility (CS) 10V													
Camera	2MP Front Camera (Optional)													
Wireless	802.11ac + BT (Optional)													
Speaker	2 x 2W Internal Speaker													
OS	<table border="1"> <tr> <td>Windows 10 IoT Enterprise</td> <td>Supported</td> <td>Drivers</td> <td>Preloaded</td> </tr> <tr> <td>Windows 11 IoT Enterprise</td> <td>Supported</td> <td>Drivers</td> <td>Preloaded</td> </tr> <tr> <td>Linux</td> <td colspan="3">Per Request</td> </tr> </table>		Windows 10 IoT Enterprise	Supported	Drivers	Preloaded	Windows 11 IoT Enterprise	Supported	Drivers	Preloaded	Linux	Per Request		
Windows 10 IoT Enterprise	Supported	Drivers	Preloaded											
Windows 11 IoT Enterprise	Supported	Drivers	Preloaded											
Linux	Per Request													
Mounting	VESA 100 x 100 mm													
Certification	FCC / CE Class B / UKCA / ESD 8KV, 15KV													
Construction/Color	Aluminum Die-Casting + Plastic / Galaxy Grey + Sliver													
Temperature	Operation: 0°C ~ 40°C (32°F ~ 104°F) Storage: -20°C ~ 60°C (-4°F ~ 140°F)													
IO Port	1 x Universal IO 1 x Cash Drawer (RJ11) 1 x Smart-DD  1 x HDMI Port 2 x COM (RJ45) 1 x USB 2.0 3 x USB 3.0 1 x Giga LAN 1 x DC-IN (20V)  1 x Smart-IO 													
Optional IO Ports via Universal IO (UIO)	 <p>UIO Options</p> 													
Optional IO ports via Smart IO Port 	 <p>Smart IO Cable Options</p> <ul style="list-style-type: none"> Smart IO-to-DC-Jack 12V Cable 75cm Smart IO-to-24V Hosiden & USB-B Y-Cable 75cm Smart IO-to-COM(DB9), RI/5V/12V Adjustable Cable 75cm Smart IO-to-DC-Jack 12V & USB-B Cable 75cm Smart IO-to-PUSB12V Cable 1M Smart IO-to-PUSB Hub, 3 x PUSB12V & 1x PUSB24V via Cable (Hub Installed Underneath Stand) 													
TPM	TPM 2.0: dTPM and fTPM/PTT													
Power	20V / 90W or 130W External Adapter													
Dimensions (W x H x D)	Panel PC: 342 x 274 x 38 mm Panel PC with Stand: 342 x 328 x 273 mm In Carton: 468 x 156 x 448 mm (18.4 x 6.1 x 17.7 in)													
Weight	Net 3.4 KG/7.5 lb Gross 4.4 KG/9.7 lb													
Inside the Product Carton	1 x PP-9745 1 x Cable COM Port RJ45 8P-DB9 1 x Power Adapter 1 x AC Power Cord													
Add-on Peripheral Options	MSR/Fingerprint/RFID/MSR+RFID 2-in1 Scanner/iButton													

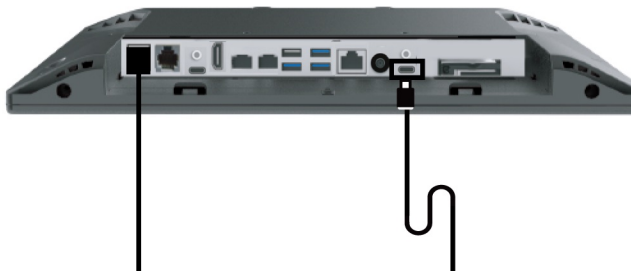

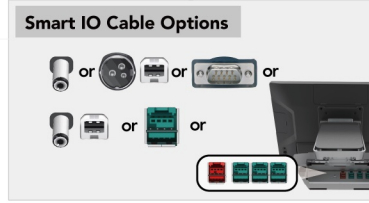
Model	PP-9745W														
Processor	12th Gen Intel® Core™ i3-12100 / i3-12100TE / i5-12400 / i5-12500TE / i7-12700	14th Gen Intel® Core™ (Optional) i3-14100T / i5-14500T / i7-14700T													
Memory	4GB Standard, Max 32GB (1 x SO-DIMM DDR4)														
Storage	1 x M.2 M key PCIe GenIII NVMe														
Display	15.6" TFT, 1920 x 1080 16:9														
Brightness	300 nits														
Touch	True-Flat PCAP (Default) / AG Coating (Optional);Conducted Susceptibility (CS) 10V														
Camera	2MP Front Camera (Optional)														
Wireless	802.11ac + BT (Optional)														
Speaker	2 x 2W Internal Speaker														
OS	<table border="1"> <tr> <td>Windows 10 IoT Enterprise</td> <td>Supported</td> <td>Drivers</td> <td>Preloaded</td> </tr> <tr> <td>Windows 11 IoT Enterprise</td> <td>Supported</td> <td>Drivers</td> <td>Preloaded</td> </tr> <tr> <td>Linux</td> <td colspan="3">Per Request</td> </tr> </table>			Windows 10 IoT Enterprise	Supported	Drivers	Preloaded	Windows 11 IoT Enterprise	Supported	Drivers	Preloaded	Linux	Per Request		
Windows 10 IoT Enterprise	Supported	Drivers	Preloaded												
Windows 11 IoT Enterprise	Supported	Drivers	Preloaded												
Linux	Per Request														
Mounting	VESA 100 x 100 mm														
Certification	FCC / CE Class B / UKCA / ESD 8KV,15KV														
Construction/Color	Aluminum Die-Casting + Plastic / Galaxy Grey + Sliver														
Temperature	Operation: 0°C ~ 40°C (32°F ~ 104°F) Storage: -20°C ~ 60°C (-4°F ~ 140°F)														
IO Port	1 x Universal IO 1 x Cash Drawer (RJ11) 1 x Smart-DD  1 x HDMI Port 2 x COM (RJ45) 1 x USB 2.0 3 x USB 3.0 1 x Giga LAN 1 x DC-IN (20V)  1 x Smart-IO 														
Optional IO Ports via Universal IO (UIO)	 UIO Options 														
Optional IO ports via Smart IO Port 	1 x PUSB 24V (Default) 1 x PUSB 12V 2 x USB 2.0 1 x COM(RJ45) 1 x 2 nd LAN (RJ45) Smart IO Cable Options  Smart IO-to-DC-Jack 12V Cable 75cm Smart IO-to-24V Hosiden & USB-B Y-Cable 75cm Smart IO-to-COM(DB9), RI/5V/12V Adjustable Cable 75cm Smart IO-to-DC-Jack 12V & USB-B Cable 75cm Smart IO-to-PUSB12V Cable 1M Smart IO-to-PUSB Hub, 3 x PUSB12V & 1x PUSB24V via Cable (Hub Installed Underneath Stand)														
TPM	TPM 2.0: dTPM and fTPM/PTT														
Power	20V / 90W or 130W External Adapter														
Dimensions (W x H x D)	Panel PC: 368 x 235 x 34 mm Panel PC with Stand: 368 x 293 x 273 mm In Carton: 468 x 156 x 448 mm (18.4 x 6.1 x 17.7 in)														
Weight	Net 3.9 KG/8.6 lb Gross 4.9 KG/10.8 lb														
Inside the Product Carton	1 x PP-9745W 1 x Cable COM Port RJ45 8P-DB9 1 x Power Adapter 1 x AC Power Cord														
Add-on Peripheral Options	MSR/Fingerprint/RFID/MSR+RFID 2-in1 Scanner/iButton														

